

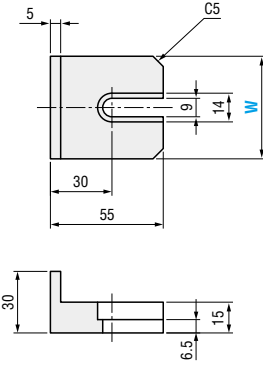

# LIFTER BLOCKS / SIDE GAUGES / REAR GAUGES / PRELOAD PINS

Lifter block **FLOLB**



Lifter block **FLOLBA**

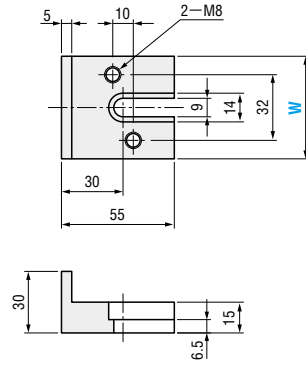

Lifter block **FLOLBB**

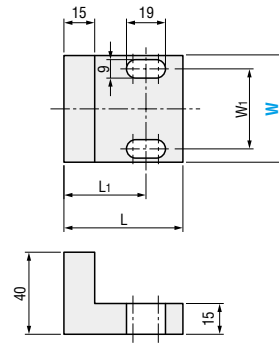

M S45C

Side gauge **FLOSG**

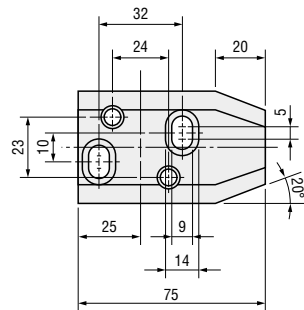
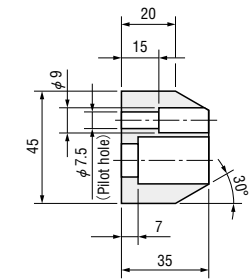

M S45C

Rear gauge **FLORG**

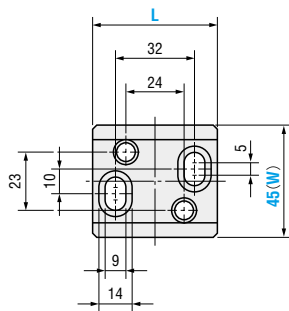
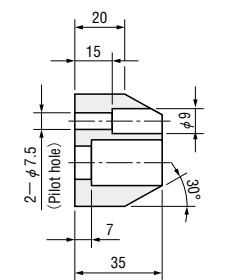

M S45C

Preload pin **FLAP**

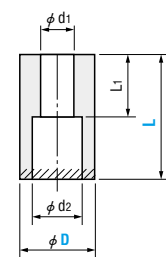

M S45C  
part is HF induction hardening.

■ Lifter block **FLOLB · FLOLBA · FLOLBB**

FLOLBB dimensions

W	W1	L	L1
52	39	58	40
62	48	64	40
65	55	80	55

Catalog No.	W
<b>FLOLB</b>	45
<b>FLOLBA</b>	50
<b>FLOLBB</b>	60
	52
	62
	75

Order

■ Side gauge **FLOSG**

Order

■ Rear gauge **FLORG**

Catalog No.	W	L
<b>FLORG</b>	45	50 55

Order

■ Preload pin **FLAP**

d1	d2	L1	Catalog No.	D	L 10mm increment	
9	14	20	<b>FLAP</b>	25	40~60	
		40			70~100	
13	20	25			30	50~60
		45			35	70~100
		65				110~150

Order

Days to Ship

Price